



Freude am Fahren

BMW Wallbox Essential

Installation instructions



BMW Wallbox Essential
Installation instructions

5

EN

BMW Wallbox Essential Installation instructions

Contents

INFORMATION	9
Safety information	9
Intended use	11
About this manual	11
Package	12
Warranty	12
OPERATION	13
Displays and controls	13
SPECIFICATIONS	14
General criteria for selecting an installation site	14
Specifications for the electrical connection	15
INSTALLATION	16
Installation requirements	16
Recommended installation positions	16
Required distance	17
Remove the housing cover	18
Removing the termination panel cover	19
Removing the terminal cover	20
Surface-mounted cable routing - Cable inlet from above	20
Surface-mounted cable routing - Cable inlet from below	21
Cable inlet from behind – cable in the wall	21
Cable openings	22
Mounting the Wallbox	23
ELECTRICS	27
Connection diagram with open termination panel cover	27
Connecting the supply cable	28
Using the supply terminals (spring-type terminal)	29
SETTINGS	31
DIP switch settings	31
COMMISSIONING	34

General commissioning procedure	34
Commissioning mode/Self-test	34
Safety tests	35
Installing the terminal cover	35
Installing the termination panel cover	35
Install the housing cover	37
MISCELLANEOUS	38
Dimensions	38
Technical data	39
MAINTENANCE	42
Replacing the fuse	42
WASTE DISPOSAL	43
SOFTWARE UPDATE	44
PRODUCT INFORMATION PAGE	45
INDEX	46

Legal information

Bayerische Motorenwerke Aktiengesellschaft

Munich, Germany

www.bmw.com

Original installation instructions

Copyright ©2019 BMW AG Munich

This documentation contains information protected by copyright. All rights reserved, especially the right of reproduction and distribution. No part of this documentation may be reproduced (photocopying, scanning or any other procedures) or processed, copied or distributed in any form using electronic systems without the written consent of Bayerische Motorenwerke Aktiengesellschaft.

Contraventions are liable to compensation.

About this manual

Keep this manual for the full service life of the product.

Read these instructions carefully and look at the device to familiarise yourself with it before you attempt to install, operate or service it. The following special information may be displayed in this documentation or on the device to warn you of possible dangers or point to information which explains or simplifies a process.

Use the operating manual to operate the Wallbox and to obtain explanations of errors on it.

Keep this manual safe for later use. The latest manuals can be downloaded from the <https://charging.bmwgroup.com/web/wbdoc/> internet at .

Symbols used

You will find information and warnings about possible dangers at various points in the manual. The symbols used in the manual have the following meanings:



WARNING

Means that death or serious physical injury may occur if the appropriate precautions are not taken. ◀



CAUTION

Means that property damage or minor physical injury may occur if the appropriate precautions are not taken. ◀



IMPORTANT

Means that property damage may occur if the appropriate precautions are not taken. ◀



ESD

This warning points out the possible consequences of touching electrostatically sensitive components. ◀



Note

Indicates procedures which do not involve any risk of injury. ◀



Note

The BMW dealer will be happy to help you find a qualified installation partner. ◀

INFORMATION

Safety information

Read the safety information carefully and look at the device to familiarise yourself with it before you attempt to install, operate or service it.



WARNING

- ▷ Electrical danger!
The Wallbox must be installed, commissioned and serviced by appropriately trained, qualified and authorised electricians⁽¹⁾ who bear full responsibility for compliance with current standards and installation regulations.
Please note that an additional overvoltage protector may be required by vehicles or national regulations.
Please refer to your national connection and installation standards.
- ▷ Before commissioning, check that all screw and clamp connections are tight!
- ▷ The terminal panel must never be left open without supervision. Fit the terminal panel cover when you leave the Wallbox.
- ▷ Do not make any unauthorised changes or modifications to the Wallbox.
- ▷ Repair work to the Wallbox is not permitted, and may be completed only by the manufacturer or a trained expert (Wallbox replacement).
- ▷ Do not remove any identifiers such as safety symbols, warning instructions, rating plates, labels or cable markings.
- ▷ The Wallbox does not have a main switch. The RCCB and circuit breaker for the building installation can be used as power cut-off device.
- ▷ Make sure that the charging cable is not mechanically damaged (kinked, jammed or run over) and that the contact area does not come into contact with heat sources, dirt, or water.
- ▷ Do not put your fingers into the connector.
- ▷ Always conduct a visual inspection for signs of damage before charging. Pay particular attention to dirt and moisture on the charging plug, cuts on the charging cable or chafing on the insulation, and also ensure that the cable output from the Wallbox is securely fastened. ◀

⁽¹⁾ People who, as a result of the training, skills and experience and knowledge of the relevant standards can assess the work and identify possible dangers.



IMPORTANT

- ▷ Never clean the Wallbox using a jet of water (hosepipe, pressure washer, etc.)!
- ▷ Ensure that the Wallbox is not damaged by incorrect handling (housing cover, internal parts, etc.).
- ▷ If it is raining or snowing and the Wallbox is installed outdoors, do not open the terminal panel cover.
- ▷ Protect the charging plug from dirt and water with the dust cap when not in use.
- ▷ Risk of breakage of the plastic housing!
 - No countersunk screws may be used for mounting!
 - Do not use force to tighten the fastening screws.
 - The mounting surface must be completely flat (max. 1 mm difference between the support or attachment points). Deflection of the housing must be avoided. ◀



Instructions for trained personnel authorised to open the device:

Danger of damage. Electronic components may be destroyed if touched.

Before handling modules, perform an electrical discharge process by touching a metallic earthed object. ◀

A failure to follow the safety information may result in a danger of death, injury or damage to the device! The device manufacturer cannot accept any liability for claims resulting from this!

Intended use

The Wallbox is a charging station for indoor and outdoor use for charging electric or plug-in hybrid vehicles. Do not connect any other devices such as electric tools. The Wallbox is designed for installation on a wall or a column. Comply with the relevant national regulations for installing and connecting the Wallbox.

The intended use of the device in every case includes compliance with the ambient conditions for which this device was developed.

The Wallbox was developed, manufactured, tested and documented on the basis of the relevant safety standards. If you comply with the instructions and safety information described for its intended use, the product will not normally pose any danger in terms of property damage or to the health of people.

This device must be earthed. In the event of an error, the earth connection will reduce the danger of an electric shock.

The instructions contained in this manual must be followed to the letter. Otherwise, sources of danger may be created or safety equipment may be rendered ineffective. In addition to the safety information provided in this manual, the safety and accident prevention regulations relating to the specific device must be followed.

As a result of technical or statutory restrictions, not all versions/options are available in all countries.

About this manual

This manual and the functions described in it are valid for devices of the following type:

▷ BMW Wallbox Essential

This manual is designed exclusively for trained personnel. These are people who, as a result of their training, skills and experience and their knowledge of the relevant standards, can assess the work assigned to them and identify possible dangers.

The illustrations and explanations contained in this manual refer to a typical version of the device. Your device version may differ from this.

The information and instructions for operating the device are provided in the operating instructions.

Package

Description	Quantity
Wallbox	1x
Installation instructions	1x
Operating manual	1x
Drilling template	1x
Double membrane seal M32 or 3/4" NPT (clamping area 14–21 mm)	1x
Double membrane seal M16 (clamping area 7–12 mm)	2x
Fastening kit for wall mounting	
Wall plugs for M8, Fischer UXR-10	4x
Wafer-head screw	4x

Warranty

BMW Service can provide more information on the terms of the warranty. However, the following cases are not covered by the warranty.

- ▷ Defects or damage caused by installation work which was not carried out as specified in the BMW Wallbox Essential installation instructions.
- ▷ Defects or damaged cause by the product not being used as specified in the BMW Wallbox Essential operating instructions.
- ▷ Costs and damage caused by repair work not carried out by a specialist electrician authorised by a BMW sales outlet or authorised service workshop.

OPERATION

Displays and controls

Version with charging cable

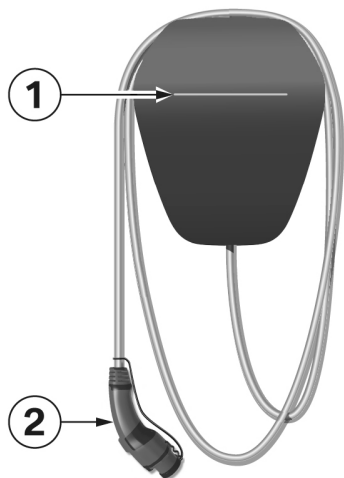

Functions:

▷ Charging electric or plug-in hybrid vehicles

1 Status LED

2 Charging cable plug

SPECIFICATIONS

General criteria for selecting an installation site

The Wallbox has been designed for indoor and outdoor use. It is therefore necessary to ensure the correct installation conditions and protection for the device at the installation site.

- ▷ Take into account the local electrical installation regulations, fire prevention regulations and accident prevention regulations as well as the rescue routes at the site.
- ▷ Do not install the Wallbox at locations:
 - ▷ Which are used as escape and rescue routes.
 - ▷ Which are inside potentially explosive zones (EX environment).
 - ▷ At which the Wallbox is exposed to ammonia or ammonia gases (for example in or near stables).
 - ▷ At which the Wallbox may be damaged by falling objects (for example suspended ladders or car tyres).
 - ▷ At which the Wallbox is on a direct personnel route and people could stumble over the connected charging cable.
 - ▷ At which the Wallbox may be struck by jets of water (for example due to neighbouring manual car wash systems, pressure washers or garden hoses).
 - ▷ At which the installation surface does not have sufficient strength to withstand the mechanical stresses.
- ▷ If possible install the Wallbox so that it is protected from direct rainfall so as to avoid the effects of weather, icing, damage by hailstones or the like.
- ▷ If possible install the Wallbox so that it is protected from direct sunlight to prevent the charging current being reduced or the charging process being interrupted as a result of excessive temperatures on components of the Wallbox.
- ▷ Comply with the permitted ambient conditions, see section [Technical data](#).
- ▷ Ensure compliance with national and international installation standards and regulations, for example IEC 60364-1 and IEC 60364-5-52.
- ▷ Ensure compliance with national regulations (for example the charging column regulation in Germany) for the implementation of the EU Directive (2014/94/EU) relating to the binding minimum technical specifications for sockets and vehicle couplings for charging electric or plug-in hybrid vehicles in areas accessible to the public. This regulation relates to charging points on public land as well as department store or customer car parks, for example. Charging points on private carports or private garage entrances are not generally publicly accessible charging points in terms of this regulation.



Note

If the device is installed in a location where it is not protected from the weather, for example in an outdoor car park, the charging current will be reduced to 16 A if the temperature exceeds the limit value. ◀

Specifications for the electrical connection

When it is delivered, the Wallbox is set to 10 A.

Make sure that you set the maximum current to suit the installed circuit breaker using the DIP switches, see section [DIP switch settings](#).

Selecting the residual-current-operated circuit breaker

The supply cable must be permanently wired into the existing building installation and comply with the national statutory regulations.

- ▷ Each Wallbox must be connected using a separate residual-current-operated circuit breaker. No other circuits may be connected to this residual-current-operated circuit breaker.
- ▷ RCCB at least Type A (30 mA trip current).
Additional action has been taken in the device to provide protection in the event of DC fault current (>6 mA DC). In addition, the specifications of the vehicle manufacturer must be observed.
- ▷ The rated current I_N must be selected to suit the circuit breaker and the back-up fuse.

Selecting the circuit breaker

When selecting the circuit breaker, also take the increased ambient temperatures in the control cabinet into consideration. In certain circumstances this may require a reduction in the charging current to increase the system availability.

Set the rated current to suit the model plate details in conjunction with the required charge rating (DIP switch settings for the charging current) and the supply cable.

Selecting the supply cable

When selecting the supply cable, take into account the possible reduction factors and the increased ambient temperatures in the internal connection area of the Wallbox, see the temperature rating of the supply terminals. In certain circumstances this may require an increase in the cable cross-section and an adjustment in the temperature resistance of the supply cable.

Mains isolation device

The Wallbox does not have its own mains switch. The residual-current-operated circuit breaker and/or the circuit breaker in the supply cable are used as a mains isolation device.

INSTALLATION



Note

The maximum charging current of the Wallbox on delivery is set to 10 A. ◀

Installation requirements

- ▷ Follow the local installation regulations.
- ▷ The electrical connection (supply cable) must be prepared.
- ▷ Acclimatisation: If there is a temperature difference of more than 15 °C between transport and the installation site, the Wallbox must be acclimatised unopened for at least two hours.

Opening the Wallbox immediately may result in condensation formation in the interior and cause damage when the device is switched on. In certain circumstances, damage caused by condensation formation may also not appear until a later date after the installation.

Ideally, the Wallbox should be stored for a few hours in advance at the installation site. If this is not possible, the Wallbox should not be stored in low temperatures (< 5 °C) overnight outdoors or in a vehicle.

Tool list

The following tools will be required for the installation work:

- ▷ Slotted screwdriver for supply terminals, blade width 5.5 mm
- ▷ Phillips screwdriver PH2
- ▷ Torx screwdriver T40

Recommended installation positions

When selecting the installation position, taken note of the position of the charge connector on your vehicle and the direction in which you normally park it. Examples:

BMW i3

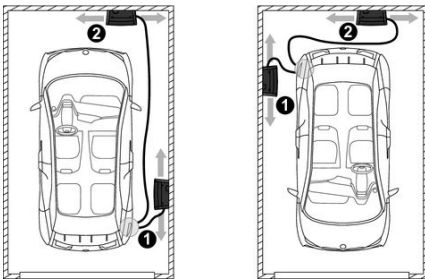

1 Recommended installation position

2 Alternative installation position

BMW/MINI PHEV

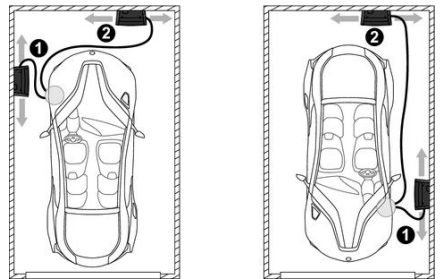

Required distance

The distance shown below (hatched area) will ensure easy installation and operation of the Wallbox. If several Wallboxes are installed next to each other, a distance of at least 200 mm (8") must be left between them.



Note

The installation height must be complied with to meet the requirements for both indoor and outdoor use. ◀

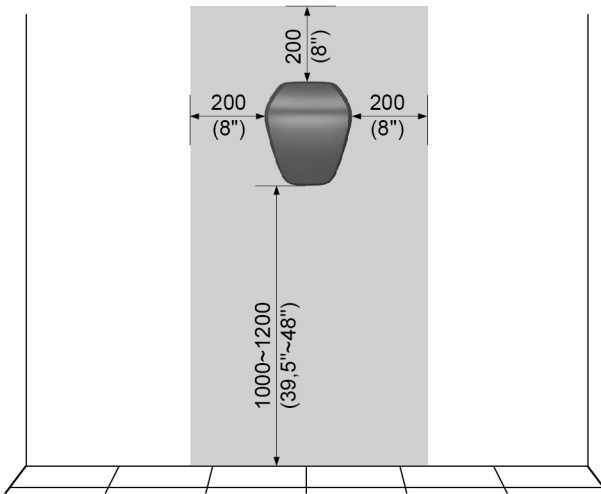

Dimensions in millimetres (inches)

Remove the housing cover

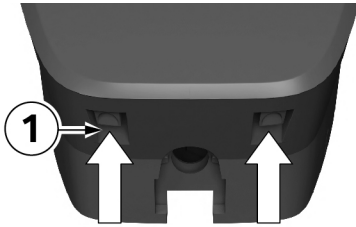

1. Press the two locks **1** for the housing cover on the underside of the Wallbox upwards. The housing cover should then jump out slightly at the bottom.



2. Swing the housing cover forwards a little on the underside **2**.
3. Then release the housing cover by raising it **3**.



Note

Keep the housing cover in the packaging to prevent it being scratched or suffering other damage. ◀

Removing the termination panel cover

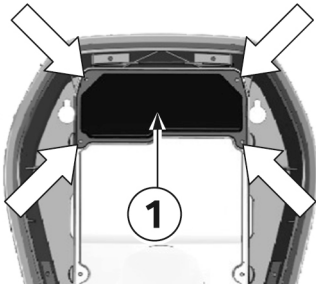

1. Undo the four screws used to secure the termination panel cover **1**.



ESD

Danger of damage. Electronic components may be destroyed if touched.

Before handling modules, perform an electrical discharge process by touching a metallic earthed object. ◀

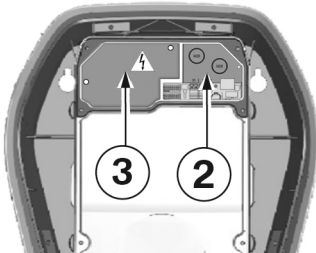

2. Remove the termination panel cover. The termination panel **2** is now accessible.
3. Remove the silica bag from the terminal panel and dispose of it properly.



WARNING

The cover over the connection area **3** for the mains voltage may only be removed by a qualified electrician. ◀

Removing the terminal cover



WARNING

Electrical danger. The terminal cover may be opened only by authorised electricians with the appropriate training and qualifications. ⚡

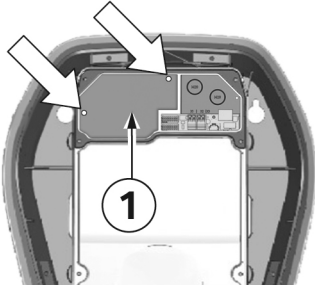

1. Undo the two fastening screws on the terminal cover **1**.
2. Remove the terminal cover over the supply terminals.

Surface-mounted cable routing - Cable inlet from above



The connection cables can be inserted from above through the housing opening in the outer frame.

1. To do this, break out the marked position **1** on the inner housing section.

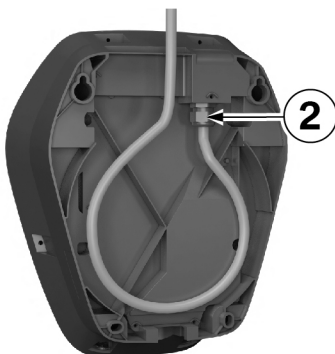

2. Lay the supply line in a loop to the cable gland **2**.
Observe the permissible bending radii of the cable.

Surface-mounted cable routing - Cable inlet from below



1. Lay the supply line in a loop to the cable gland
2. Observe the permissible bending radii of the cable.

Cable inlet from behind – cable in the wall



Note

The cable is to be inserted straight out of the wall into the rear of the device. Ensure that the Wallbox is correctly positioned so that the cable opening is directly above the cable. Ensure that you comply with the minimum bending radii. Use the drilling template with the appropriate punching for the cable to ensure the correct alignment of the Wallbox above the wall outlet. ◀

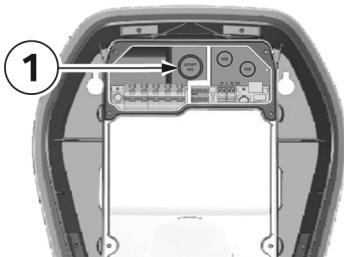

Cable openings

- 1 Bushing/Double membrane seal M32, supply cable

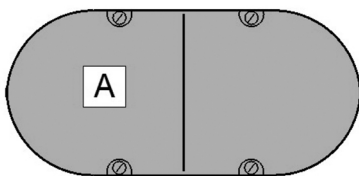

Flush-mounted socket

A double flush-mounted socket with a separating web may be used for safe separation.

- A** Supply cable

Cable openings

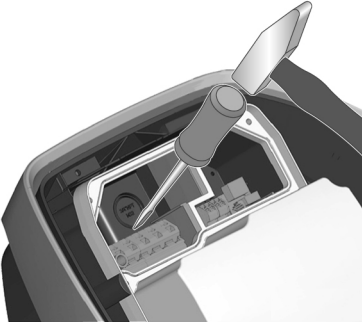

Break off cable openings

1. Place the housing on a stable surface.
2. Carefully remove the required cable openings using a hammer and slot head screwdriver.
3. Then insert the appropriate bushings, cable glands or double membrane seals.
4. Fit the Wallbox with the supplied cable glands or blind glands if a cable opening is no longer to be used.

Mounting the Wallbox

The supplied mounting material is suitable for concrete, brick and wood (without rawl plugs). If the surface is different, a suitable type of mounting must be selected.



Note

The fastening materials must be provided by the customer for different surfaces. Correct installation is essential and is not the responsibility of the device manufacturer. ◀

Assembly preparations

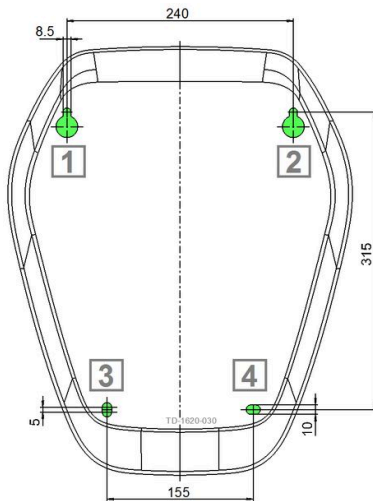

Drill holes



Note

Observe the installation height.

Upper edge of the drilling template = 1500 - 1700 mm. ◀

1. Draw the four drill holes **1** to **4** using the enclosed drilling template and a spirit level.
2. Drill the mounting holes.
3. Insert the rawl plugs.

Upper fastening screws

1. Screw in the two top wafer-head screws, with a distance to the wall ≥ 20 mm.

- 1** Wall
- 2** Rawl plug
- 3** Drill hole
- 4** Wafer-head screw

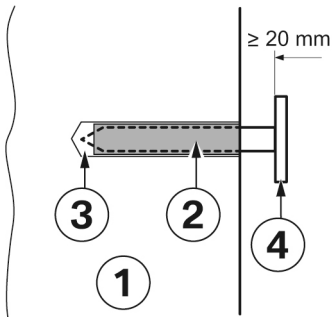



Installation on cavity walls

For installation on cavity walls, at least two fastening screws, for example **1** and **2**, must be fastened to a solid element in the wall.

Special cavity wall rawl plugs must be used for the other fastening screws.



Note

When mounting on cavity walls, special care must be taken to ensure that the structure has sufficient load-bearing capacity. ◀

Insert the supply cable

General information

- ▷ Use a suitable cable sheath diameter on the supply cable or increase the cable sheath diameter using suitable sealing adapters.
- ▷ Insert the supply cable a sufficient way into the cable gland or double membrane seal. The cable sheath must be visible in the connection zone.
- ▷ The installation pipe or empty pipework with the supply cable must not be screwed into the cable gland or fed through the double membrane seal.
- ▷ The supply cable must be routed in a straight line not exceeding the bending radii (approximate cable diameter times 10) through the cable gland or double membrane seal.
- ▷ The cable gland or double membrane seal must be installed correctly and adequately secured.

Cable routing from above/below

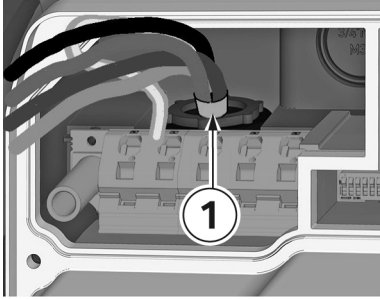

1. Route the supply cable through the cable gland and tighten the gland.

The cable sheath **1** must be visible in the connection zone.

Cable routing from behind (flush-mounted)

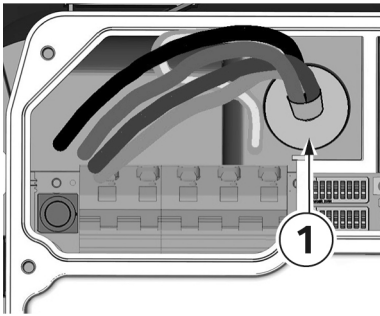

1. The supply line must be routed through the bushing/double membrane seal **1** as shown.



IMPORTANT

- ▷ Make sure that the double membrane seal fits neatly against the cable sheath.
- ▷ Make sure that the supply line is inserted centrally, straight and pressure-free through the double membrane seal and that a tight fit is guaranteed. ◀

Mounting the Wallbox

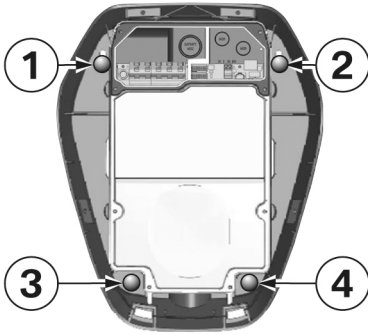

1. After the cables are inserted, mount the Wallbox onto the two top wafer-head screws **1** and **2**.



Note

Ensure that the supply cable is correctly routed to the rear and is not jammed. ◀

2. Tighten the wafer-head screws **1** and **2**.
3. Then secure the Wallbox with the two bottom wafer-head screws **3** and **4**.
4. Wrap the charging cable around the Wallbox for safe storage, see operating instructions.

ELECTRICS

Connection diagram with open termination panel cover

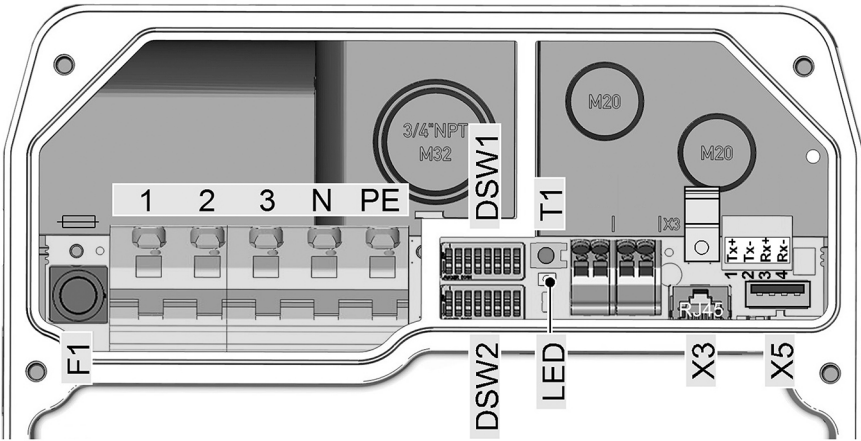

- 1** Mains connection outer conductor 1
- 2** Mains connection outer conductor 2
- 3** Mains connection outer conductor 3
- N** Mains connection, N conductor
- PE** mains connection, PE conductor
- F1** Fuse holder

- DSW1** DIP switch for configuration
- DSW2** DIP switch for addressing
- T1** Service button
- LED** Status LED, internal
- X3** Diagnostic connector, RJ45
- X5** USB connector



IMPORTANT

The X3 diagnostic connection is suitable only for error analysis and must not be used to connect the device to a network. ◀



Note

The connection overview shows all the options of the device, but the legend only lists the available options. It is possible that your version of the device will not have all the connections available. ◀

Connecting the supply cable

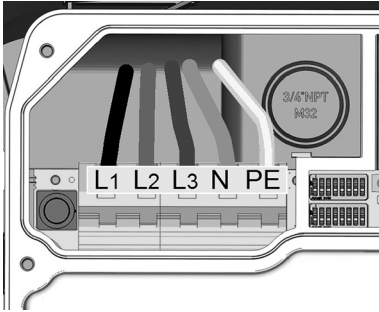

1. Cut the connecting wires to the appropriate length. They should be kept as short as possible.



Note

The PE conductor must be longer than the other conductors. ◀

2. Strip approximately 12 mm of insulation of the connecting wires. We recommend the use of wire-end ferrules for fine connecting wires.
3. Connect the supply cable **L1**, **L2**, **L3**, **N** and **PE**.

1-phase connection

It is also possible to connect the Wallbox on a 1-phase basis. Use terminals **L1**, **N** and **PE** for this purpose.



Note

Make a note of which outer conductor you connect to terminal **L1** if you are installing multiple Wallboxes in a group. ◀

Technical data of the connection terminal

- ▷ Rigid (min.-max.): 0.2 – 16 mm²
- ▷ Flexible (min.-max.): 0.2 – 16 mm²
- ▷ AWG (min.-max.): 24 – 6
- ▷ Flexible (min.-max.) with wire-end ferrule:
without/with plastic sleeve
0.25 – 10/0.25 – 10 mm²
- ▷ Stripping length: 12 mm

Using the supply terminals (spring-type terminal)



IMPORTANT

This terminal is not a clamp-type terminal and must be activated for the connection. If the terminal is not completely opened before the cable is connected, it is possible that the device will function when it is commissioned but is then damaged during the first charging cycle with high current through overheating. ◀



Note

Danger of breaking the terminal.

Do not lever the screwdriver upwards, downwards or to the side. ◀

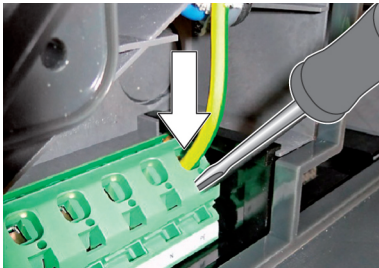
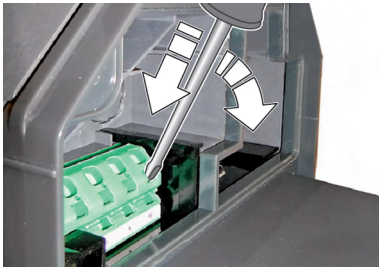
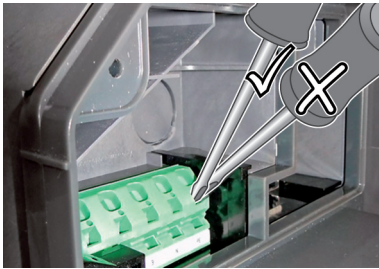

Open the supply terminal

1. Slide a slotted head screwdriver with a width of **5.5 mm**, as shown in the illustration, into the supply terminal.
2. Press the screwdriver into the supply terminal.



Note

As you press the screwdriver into the terminal, its angle will change. ◀

Connect the wire

1. Slide the stripped connecting wire into the supply terminal.



IMPORTANT

If you attempt to slide in the wire when the terminal is not open, there is a risk of fire due to inadequate contact. ◀

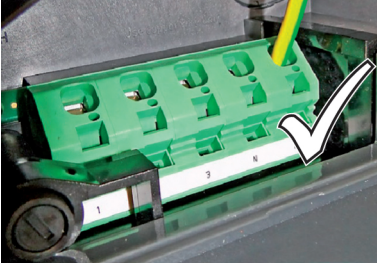

Close the supply terminal

1. Pull the screwdriver fully out of the terminal to close the contact.
2. Check that the connecting wire is secure.
3. Connect the other connecting wires in the same way.

SETTINGS

DIP switch settings



Note

Changes to the DIP switch settings do not take effect until the Wallbox has been restarted! To do so, press **service button** until the 1st signal tone sounds (around 2 seconds). Alternatively, you can also switch the supply voltage off and on again. ◀



Note

Switches which are not described here must be left in the OFF position. ◀

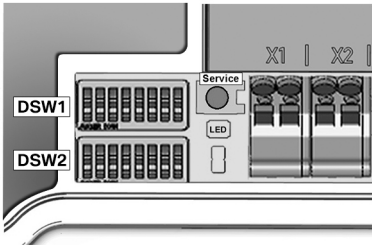

DIP switches

The DIP switches are used to address and configure the Wallbox and are located under the terminal panel cover.

DSW1: Configuration, DIP switch up

DSW2: Addressing, DIP switch down

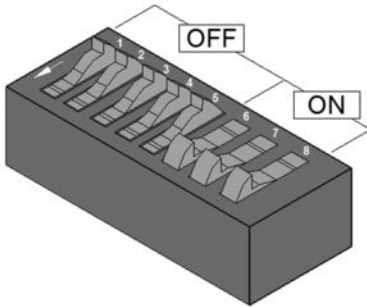





DIP switch specimen illustration

For a better explanation, the figure shows the position of the DIP switches for the ON and OFF states.

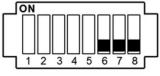
Maximum charge current (DSW1)

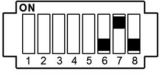
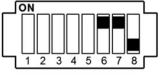
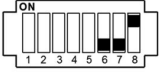
The following DIP switches can be used to set a maximum value for the charge current. This maximum value is valid for each connected phase individually and not as a total value for all phases together. The power input is transmitted to the vehicle (Control Pilot Duty Cycle). A maximum value can only be set which is less than or equal to the operating current according to the rating plate.

Current	DIP switch			Illustration
	DSW1.6	DSW1.7	DSW1.8	
0 A	ON	ON	ON	
10 A	OFF	OFF	OFF	
13 A	ON	OFF	OFF	
16 A	OFF	ON	OFF	
20 A	ON	ON	OFF	
25 A	OFF	OFF	ON	
32 A	ON	OFF	ON	

Commissioning mode (DSW2.8)

Activate commissioning mode, see section Commissioning mode/Self-test .	DSW2.8	ON = yes	
---	---------------	-----------------	--

COMMISSIONING

General commissioning procedure

- ▷ Clean the connection area (remove material residues and dirt).
- ▷ Before commissioning, check that all screw and clamp connections are tight!
- ▷ Check that all unused cable glands are properly sealed with dummy plugs or dummy connections.
- ▷ Switch on the supply voltage. After the self-test, the status LED (LED bar) must light up blue after 15-20 seconds.
- ▷ Complete the specified initial tests in compliance with local regulations and laws.
- ▷ Close the Wallbox terminal panel cover if it has been opened, see section [Installing the termination panel cover](#).
- ▷ Install the housing cover, see section [Install the housing cover](#).

Commissioning mode/Self-test

The Wallbox can be switched to commissioning mode to support the initial system test. A device self-test is carried out (lock, contactor control, current measurement, etc.) and an error is displayed.

After a successful test without the vehicle connected, the contactor is switched for a limited time (~10 minutes) to enable the initial tests. Normal charging is not possible in commissioning mode.

For safety reasons, switching on the Wallbox in commissioning mode via the supply voltage leads to an error (white-red-red) in order to prevent unattended activation.

Activating commissioning mode

1. Set the DIP switch **DSW2.8** to **ON**.
2. Reset the Wallbox. To do this, press the **Service button** for **1 second** (signal tone). Commissioning mode is now enabled and is indicated by the status LED being lit in orange.
3. It is now possible for approximately 10 minutes to contact with the measuring instrument using standard test clips (for example Astaco® test clips from BEHA) and conduct the required safety tests. After this time the contactor is disabled and the Wallbox switched off.

Deactivating commissioning mode

1. Set the DIP switch **DSW2.8** back to **OFF**.
2. Reset the Wallbox. To do this, press the **Service button** for **1 second** (signal tone) or switch the supply voltage off and on again. The Wallbox starts up in normal operating mode and is ready for operation.

Safety tests

Before using the device for the first time, check the effectiveness of the system's protective measure(s) according to national regulations such as ÖVE/ÖNORM E8001-6-61, DIN VDE 0100-600.

Check that the effectiveness of the safety feature(s) of the system complies with national regulations before commissioning the device.

Electrical systems or devices must be tested by the installer of the system or device before being used for the first time. This also applies to the extension or modification of existing systems or electrical devices. However, it must be clearly repeated at this point that compliance with all regulations for the protection measures is mandatory.

Among others, the following points must be given due consideration:

1. The tests: Continuity of the protective conductor connections, insulation resistance, residual-current-operated circuit-breaker tripping current and trip time must be conducted for the extended or modified part.
2. The measuring instruments used must comply with national regulations, for example DIN EN 60557 (VDE 0413) "Electrical safety in low voltage networks up to AC 1000 V and DC 1500 V".
3. The meters used must comply with national regulations.
4. The measurements must be documented. A test log must be prepared for the test and archived.

Installing the terminal cover

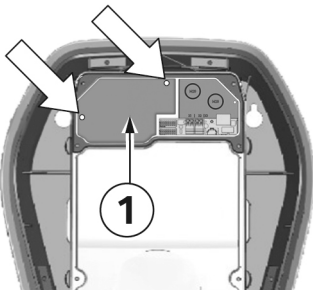

Fastening screws

1. Install the terminal cover **1** again using the two fastening screws if they have been removed.

Installing the termination panel cover



Note

Confirm that an up-to-date version of the software is available before you install the terminal panel cover. For further information see section [SOFTWARE UPDATE](#). ◀



Note

The Wallbox must not be permanently commissioned if this cover is missing or damaged. Alternative covers must not be used. ◀

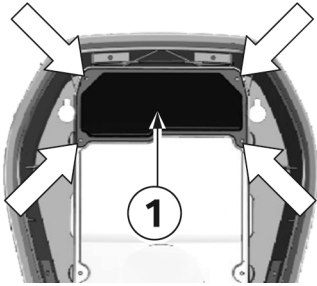

Fastening screws

1. Insert the termination panel cover **1** again.
2. Install the termination panel cover again using the four screws.

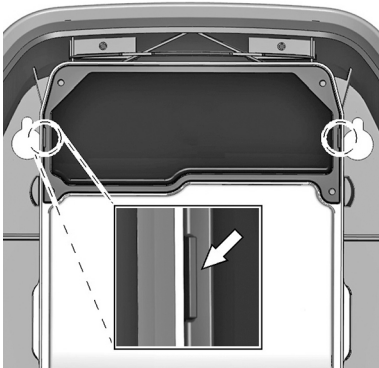

Housing marking

1. Tighten the four screws until the housing markings on the right and left on the termination panel cover are flush with the housing.
2. The termination panel cover must correctly seal the housing.

Increased force is required for the self-tapping screws: 3.5 Nm.

Install the housing cover



Note

This cover is not relevant for the safe operation of the Wallbox. ◀

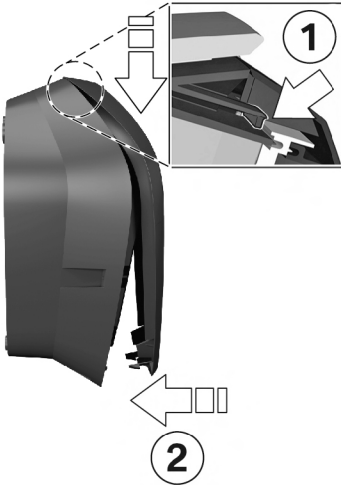

Attach the housing cover

1. Attach the housing cover at the top, and ensure that the hooks on the housing cover are correctly attached **1**.
2. Press the cover downwards and then swing the housing cover **2** backwards. The housing cover must slide into the bottom guides without any major resistance.



CAUTION

Make sure that the housing cover is correctly positioned in the housing guide on all sides. There must be only a uniform minimum gap. ◀

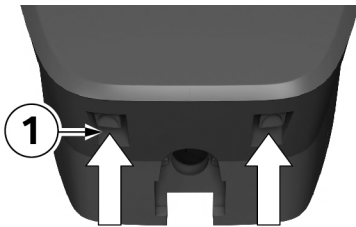

Locks

1. Press the bottom section of the housing cover on to the Wallbox until the locks **1** fully engage.

MISCELLANEOUS

Dimensions

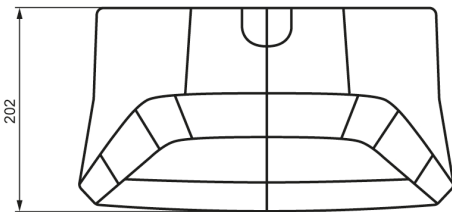
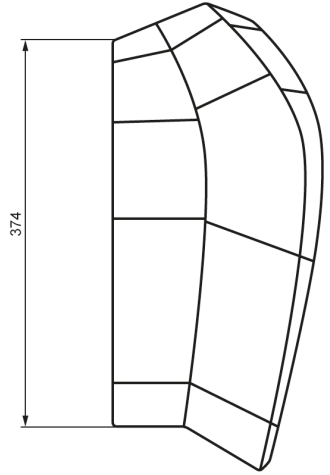
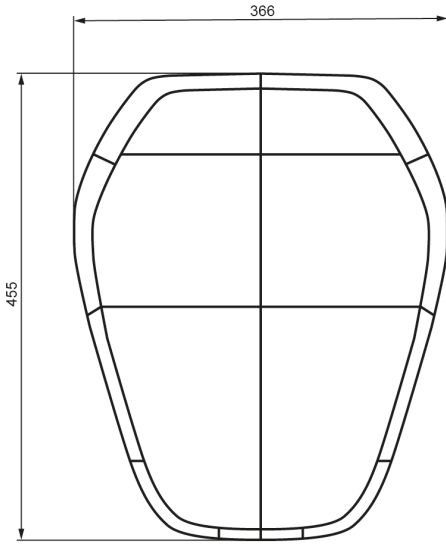

Dimensions in millimetres

Technical data

Electrical data	
Charging mode:	Mode 3 as per IEC 61851-1
Cable feed:	Surface-mounted or flush-mounted
Connection cross-section:	Minimum cross-section (depending on the cable and type of installation): - 5 x 2.5 mm ² (16 A nominal current) - 5 x 6.0 mm ² (32 A nominal current)
Supply terminals:	Connection cable: - rigid (min.-max.): 0.2 – 16 mm ² - flexible (min.-max.): 0.2 – 16 mm ² - AWG (min.-max.): 24 – 6 - flexible (min.-max.) with wire-end ferrule with/without plastic sleeve: 0.25 – 10 / 0.25 – 10 mm ²
Temperature rating of supply terminals:	105 °C
Rated current (configurable connection values):	10 A, 13 A, 16 A, 20 A, 25 A or 32 A 3-phase or 1-phase
Mains voltage:	220-240 V~ 220/380 - 240/415 V 3N~
Mains frequency:	50 Hz/60 Hz
Mains configuration:	TT/TN/IT
Overvoltage category:	III as per EN 60664
Rated short-time current resistance:	< 10 kA effective value to EN 61439-1
Fuse (in the domestic installation):	The fusing must comply with the local regulations depending on the socket/cable version (see rating plate).
DC residual current monitoring:	≤ 6 mA DC (integral)
Ventilation during charging:	Not supported

Electrical data	
Charging cable:	Type 2 cable: up to 32 A / 400 VAC as per EN 62196-1 and EN 62196-2
Protection class:	I
Device's IP protection class:	IP54
Protection against mechanical impact:	IK08

Mechanical data	
Dimensions (W x H x D)	366 x 455 x 202 mm (without connector)
Weight:	approx. 8 kg (depending on version)
Assembly (stationary):	On the wall or on the column

Ambient conditions	
Use:	Indoor and outdoor use
Operating temperature at 16 A:	-25 °C to +50 °C without direct sunlight
Operating temperature at 32 A:	-25 °C to +40 °C without direct sunlight
Temperature properties:	<p>This is not a safety device, it is just an operating function. The specified operating temperature range must not be exceeded.</p> <p>Within the specified operating temperature ranges the devices will provide the charging current continuously.</p> <p>In order to increase the charging availability, the charging current level is reduced to 16 A if the temperature is exceeded. The charging cycle may subsequently also be shut down. The charging cycle is continued, and the charging current value is increased again after cooling.</p>

Ambient conditions	
Storage temperature range:	-30 °C to +80 °C (-22 °F to 176 °F)
Temperature change rate:	max. 0.5 °C/min (max. 32.9 °F/min)
Permitted relative humidity:	5 % to 95 %, non-condensing
Altitude:	max. 2000 m above sea level

MAINTENANCE

Replacing the fuse

Fuse	Current/Voltage	Types	Dimensions
F1	6.3 A / 250 V	Slow-action with high shut-down capacity (>1500 A) (T) (H)	5 x 20 mm fuse



WARNING

Electrical danger.

The terminal cover may only be opened by authorised electricians with the appropriate training and qualifications. ◀



ESD

Danger of damage. Electronic components may be destroyed if touched.

Before handling modules, perform an electrical discharge process by touching a metallic earthed object. ◀

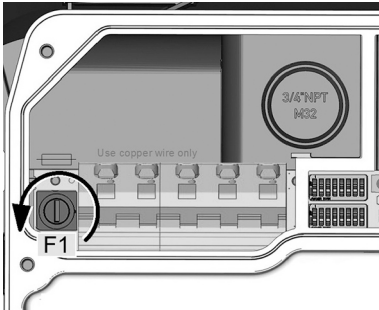

Replace fuse

1. Switch off the supply cable to the Wallbox completely.
2. Remove the housing cover, see section [Remove the housing cover](#).
3. Remove the terminal panel cover and terminal cover, see sections entitled [Removing the termination panel cover](#) and [Removing the terminal cover](#).
4. Press a screwdriver into the opening of the fuse holder.
5. Turn the fuse holder anti-clockwise until it automatically jumps forward due to the spring.
6. Replace the fuse.
7. Press the fuse holder into place and secure it again by turning it clockwise.
8. Assemble the device again following the instructions above in reverse order.

WASTE DISPOSAL



After proper decommissioning of the device, please have the device disposed of by service or dispose of it in compliance with all currently valid disposal regulations.



Waste disposal information

The symbol of the crossed out really been means that electrical and electronic devices and the accessories must be disposed of separately from general household waste. Information is provided on the product, in the instructions for use or on the packaging.

The materials can be recycled on the basis of their identifying marks. You can make a valuable contribution to protecting our environment by reusing them, recycling the material or other forms of reuse of end of life devices.

SOFTWARE UPDATE

The software for the Wallbox can also be updated using the USB connector inside the device. The housing cover and the terminal panel cover must be removed to gain access to the USB connector.

Follow the instructions in the manual for performing software updates.



The latest **software** and associated instructions can be downloaded from the internet at <https://charging.bmwgroup.com/web/wbdoc/>. A new software version may, for example, take account of changed standards or improve compatibility with new electric or plug-in hybrid vehicles.

PRODUCT INFORMATION PAGE



This telecommunications equipment complies with the NTC requirement.

INDEX

A

About this manual..... 11

B

BMW Wallbox overview..... 13

C

Cable inlet from above..... 20

Cable inlet from the rear..... 21

Circuit breaker..... 15

Commissioning..... 34

Commissioning mode/self-test..... 34

Connection diagram with open termination panel cover..... 27

Connect the supply cable..... 28

D

DIP switch settings..... 31

Disposal..... 43

F

Fuse..... 42

G

General criteria for selecting an installation site..... 14

I

Insert the supply cable..... 25

Installation..... 12, 16

Installation requirements..... 16

Installing the terminal cover..... 35

Install the housing cover..... 37

Install the termination panel cover..... 36

Intended use..... 11

L

Legal information..... 7

M

Mains isolation device..... 15

Mounting the Wallbox..... 23, 26

P

Package..... 12

Prepare cable inlet.....	22
--------------------------	----

R

Recommended installation positions.....	16
Remove the housing cover.....	18
Remove the terminal cover.....	20
Remove the termination panel cover.....	19
Required distance.....	17
Residual-current-operated circuit breaker.....	15

S

Safety instructions.....	9
Safety tests.....	35
Supply cable.....	15

T

Technical data.....	39
Tool list.....	16

U

Use of the supply terminals.....	29
----------------------------------	----

EU Declaration of Conformity

We declare that the following product(s)

Name of product	Wallbox 22kW T2
BMW part number	61 90 2412818
Model / Type Ref.	BMW-10-EC240512-000
Type of product	Electric vehicle conductive charging system

Name of product	Wallbox Essential 22kW T2
BMW part number	61 90 2472421
Model / Type Ref.	BMW-20-EC240512-000
Type of product	Electric vehicle conductive charging system

Name of product	Wallbox Essential 22kW T2
BMW part number	61 90 2472422
Model / Type Ref.	MIN-20-EC240512-000
Type of product	Electric vehicle conductive charging system

Company
Bayerische
Motoren Werke
Aktiengesellschaft

Issuing department
CP-152
Product Management
Accessories
Electric, consumer
electronics & eMobility

Postal address
BMW AG
80788 München

Office address
Frankfurter Ring 7-9
80807 München

Telephone
Switchboard
+49 89 382-0

Fax
+49 89 382-25858

Internet
www.bmwgroup.com

Bank details
Deutsche Bank
IBAN DE05 7007 0010
0152 6946 00
BIC DEUTDE33XXX

**Chairman of the
Supervisory Board**
Norbert Reithofer

Board of Management
Harald Krüger,
Chairman
Milagros Caiña Carreiro-
Andree
Klaus Fröhlich
Pieter Nota
Nicolas Peter
Ian Peter
Schwarzenbauer
Andreas Wendt
Oliver Zipse

**Registered in
Germany**
München HRB 42243

is/are in conformity with the following European Council Directive(s):

- **EU-Directive 2014/30/EU**
- **EU-Directive 2014/35/EU**
- **EU-Directive 2011/65/EU**

The conformity to the directive 2014/30/EU is assured by the compliance with the applicable parts of the following harmonized European standards:

- **EN 61000-6-2:2005**
- **EN 61000-6-3:2007 + A1:2011**
- **EN 61000-3-11:2000**
- **EN 61000-3-12:2011**

The conformity to the directive 2014/35/EU is assured by the compliance with the applicable parts of the following harmonized European standards:

- **EN 61851-1:2011**
- **EN 61851-22:2002**
- **EN 61439-1:2011**

Conformity to the directive 2011/65/EU is assured by the compliance with the applicable parts of the following harmonized European standards:

- **EN 50581:2012**

Important notes:

Any modification on the product(s) that is performed without the consent of BMW will render this declaration invalid. This declaration certifies the conformity with the directives mentioned, but does not imply any warranty of the features of the product(s). The safety instructions contained in the documentation supplied with the product(s) must be followed.

This declaration of conformity is issued under the sole responsibility of the manufacturer.

München, 11.04.2019

Place, Date

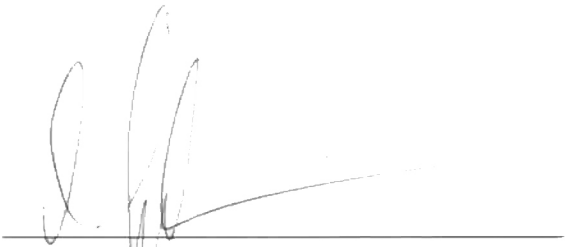
A handwritten signature in black ink, appearing to read 'M. Fischmann', is written over a horizontal line.

Michael Fischmann
CP-152, Product Management Accessories

Mehr über BMW

www.bmw.de
www.bmw.com



Freude am Fahren



Doc #108148 - Mat #108148